

06.23

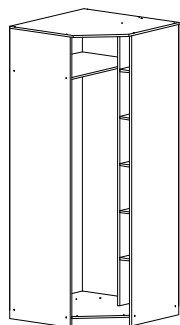

2274 824 824

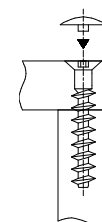

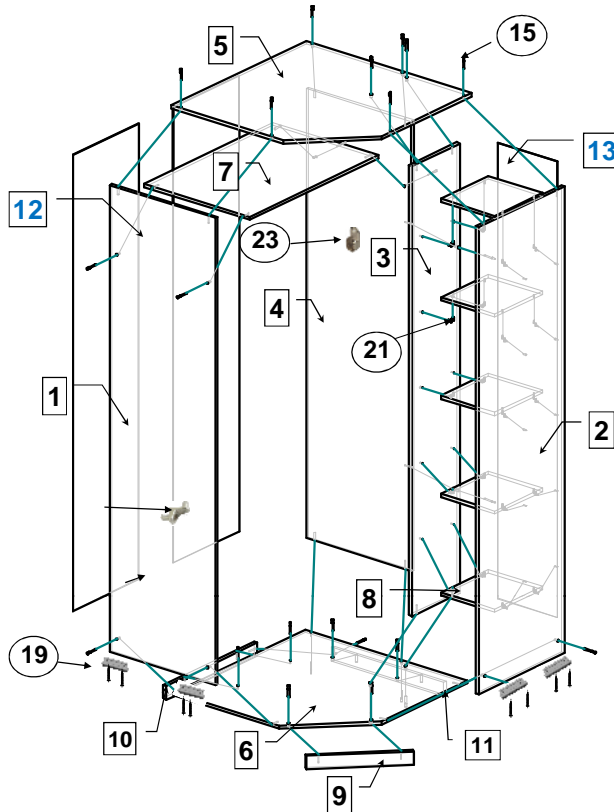

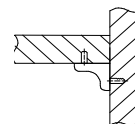





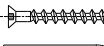

7 \* 50

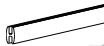

1	.06.23.00.34.00		2258 x 522	1	16,0	1/2
2	.06.23.00.35.00		2258 x 522	1	16,0	1/2
3	.06.23.00.36.00		2176 x 290	1	16,0	1/2
4	.06.23.00.37.00		2176 x 520	1	16,0	1/2
5	.06.23.00.38.00		820 x 820	1	16,0	2/2
6	.06.23.00.39.00		802 x 802	1	16,0	2/2
7	.06.23.00.40.00		786 x 520	1	16,0	2/2
8	.06.23.00.41.00		266 x 288	5	16,0	2/2
9	.06.23.00.08.00		416 x 65	1	16,0	2/2
10	.06.23.00.10.00		554 x 65	1	16,0	2/2
11	.06.23.00.11.00		554 x 65	1	16,0	2/2
12	.06.23.00.39.00		2205 x 405	2	4,0	1/2
13	.06.23.00.39.00		2205 x 295	1	4,0	1/2

\*\*\*

( .19). .1,2 .10,11 3 16 ( .24)  
 ( .15) .9,10,11 .5.  
 .1,2,3,4 .5,6,7.  
 .12,13 3 16 ( .24), .12  
 ( .18). .8 ( .21).  
 4 16 ( .26) .1 2.  
 ( .17) 4 16 ( .26).  
 ( .23). ( .20). 3,5 16 ( .25)  
 ( .22).

	15	14
	16	7 50
	17	1
	18	45
	19	L=2150
	20	8
	21	2
	22	20
	23	L=780
	24	2
	25	3 * 16
	26	3,5 * 16
	27	4 * 16

- 1.
- 1.1
- 2.
- 2.1
- 2.2
- 2.3
- 2.4

+5 40

+40

025/2012 " " 16371 – 2014 « »

24

( ).

025/2012, 16371 – 2014

---

( )

10

606 400

WEB- : www.olmeko.ru / 8(83144) 66-777

27.

